



5300 Series

Grade 2 Cylindrical Knob Locks

built to last

Yale® 5300 series standard-duty cylindrical locksets offer a unique combination of positive security, trim design variety and quality construction. They are designed for residential and various commercial applications and are the choice of engineers worldwide.

The 5300 series key-in-knob locksets provide *Yale* pin-tumbler cylinder security, and are available in a wide choice of keying options: keyed different, keyed alike, construction keying and master-keying. *Yale* 5300 Series locksets are also available in a variety of functions, trim designs and finishes. A selection can easily be made to meet the intention of most any designer or engineering/security specialist.

ANSI/BHMA

Certified ANSI/BHMA A156.2, Series 4000 Grade 2.



backset

Standard 2-3/4", 2-3/8" or 3-3/4". Special order extension links for 5", 6", 7", 10" and 18" are also available. See latchbolts page 7.

door thickness

Adjustable for doors 1-3/8" to 1-3/4". They can also be supplied for doors over 1-3/4" to 2-1/4", by using special roses and mounting plate.

fire listings

All functions are UL - cUL Fire Listed for use on fire doors having a rating up to and including 3 hours.

handing

Locksets are shipped for right-hand applications, but are field reversible for installation on doors of either hand.

latchbolts

Standard 1/2" throw, deadlocking or plain. All latchbolts are interchangeable. See latchbolts, page 7.

strikes

1-1/4" (32mm) curved lip ANSI 497 supplied standard. Optional 1" (25mm), 1-1/2" (38mm), 1-3/4" (44mm) and 2" (51mm) curved lips with wrought boxes available to order. See strikes page 8.

installation

5300 series cylindrical locks conform to ANSI/BHMA Specifications A156.115 which cover hardware preparations for steel doors and steel frames and A156.115-W which cover hardware preparations for wood doors with wood or steel frames.

lockcase

2-1/16" diameter. All functions furnished in one standard size lock case.

warranty

The 5300 series cylindrical knob lock carries a two-year warranty.

contents

Introduction	2
Features	2
Knob Designs.....	3
Functions	4-5
Cylinders	6
Latchbolts	7
Strikes	8
Ordering Information.....	9
Sample Specification.....	10

finishes

ANSI/BHMA Code	Finish Description
605	Bright Brass, Clear Coated
606	Satin Brass, Clear Coated
612	Satin Bronze, Clear Coated
613	Dark Oxidized Satin Bronze, Oil Rubbed ¹
625	Bright Chrome Plated
626	Satin Chrome Plated
722	Black Oxidized Bronze, Oil Rubbed ²

1. New May 1, 2010
2. Formerly 613 prior to May 1, 2010

quality construction

Lock mechanism is made of heavy-gauge cold rolled steel. All parts are zinc-plated and dichromated to ensure maximum resistance to corrosion. These are recommended for application in normal climatic and environmental conditions.

deadlocking guardbolt

When the latchbolt is engaged in the strike, the guardbolt is depressed and automatically locks the latchbolt in the extended position. The deadlocking guardbolt is furnished standard with all keyed functions.

5300 series | cylindrical knob locks

knob designs

Carolina CA

- Knob:** Cold forged
- Rose:** Cold forged
- Material:** Brass, Bronze

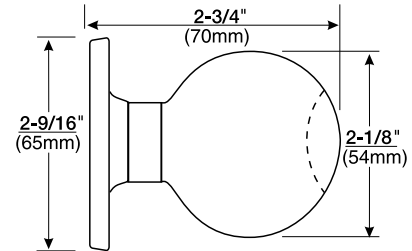

Litchfield LF

- Knob:** Cold forged
- Rose:** Cold forged
- Material:** Brass, Bronze, Stainless Steel

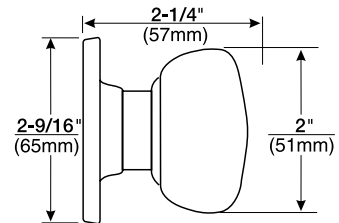

functions

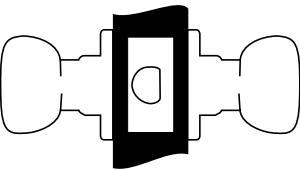
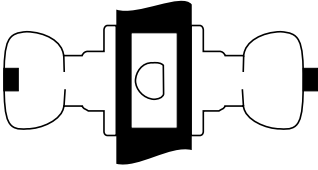
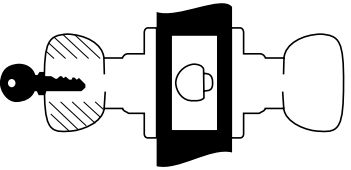
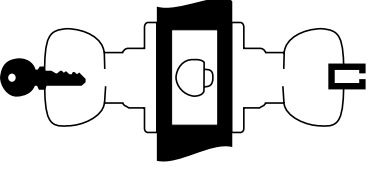
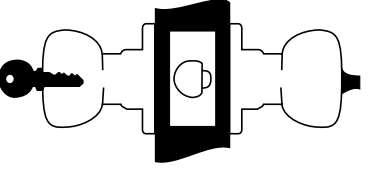
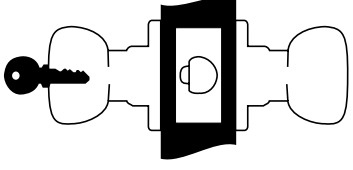
<p style="text-align: center;">5301 (F75)</p> <p>Passage or Closet Latch</p> <ul style="list-style-type: none"> • For doors that do not require locking. • Either knob operates latchbolt at all times.  <p style="display: flex; justify-content: space-around;"> Outside Inside </p>	<p style="text-align: center;">5302 (F76B)</p> <p>Privacy, Bedroom or Bath Lock</p> <ul style="list-style-type: none"> • For lavatory or other privacy doors. • Either knob operates latchbolt unless outside knob is locked by push-button inside. • Button automatically released when inside knob is turned or door is closed. • Emergency key inserted and turned in hole in outside knob will unlock door from outside. (Emergency key furnished with lock.) • Inside knob always active.  <p style="display: flex; justify-content: space-around;"> Outside Inside </p>	<p style="text-align: center;">5305 (F86)</p> <p>Storeroom or Closet Lock</p> <ul style="list-style-type: none"> • For use on storeroom, utility, exit doors. • Deadlocking latchbolt. • Latchbolt operated by knob inside, key in outside knob. • Outside knob always rigid. • Inside knob always active.  <p style="display: flex; justify-content: space-around;"> Outside Inside </p>
<p style="text-align: center;">5306 (F92)</p> <p>Service Station Lock</p> <ul style="list-style-type: none"> • Deadlocking latchbolt. • Either knob operates latchbolt. • Push-button locks outside knob. • Push-button automatically releases when inside knob is turned, door is closed, or key is rotated in outside knob (except when slotted push-button is rotated 90° clockwise to retain outside knob in lock position). • Lock opened by key in outside knob • Inside knob always active.  <p style="display: flex; justify-content: space-around;"> Outside Inside </p>	<p style="text-align: center;">5307 (F109)</p> <p>Entry Lock</p> <ul style="list-style-type: none"> • For entrance, general home or office doors. • Deadlocking latchbolt. • Either knob operates latchbolt (except when outside knob is locked from inside). • Pushing turn button in inside knob locks outside knob. (Automatically releases when inside knob is turned or key is rotated in locked outside knob.) • Outside knob may be retained in locked position by pushing and rotating turn button 90° clockwise to a horizontal position; not released until turn button is manually returned to the vertical position. • Latchbolt is operated by key in outside knob or by rotating inside knob. • Inside knob always active.  <p style="display: flex; justify-content: space-around;"> Outside Inside </p>	<p style="text-align: center;">5308 (F84)</p> <p>Classroom Lock</p> <ul style="list-style-type: none"> • For classroom or utility room doors. • Deadlocking latchbolt. • Either knob operates latchbolt (except when outside knob is locked by key). • Inside knob is always active. • Key releases outside knob.  <p style="display: flex; justify-content: space-around;"> Outside Inside </p>

functions

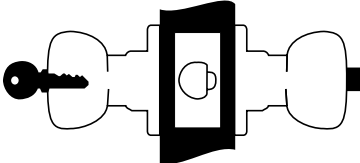
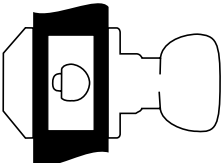
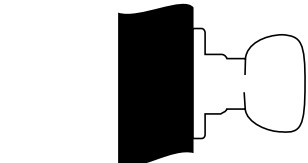
5322 (F90)	5328 (F111)	355
<p>Corridor Lock</p> <ul style="list-style-type: none"> • Deadlocking latchbolt. • Either knob operates latchbolt (except when outside knob is locked by inside push-button or key in outside knob). Inside knob always active. • When locked by button, the button automatically releases when inside knob is turned or door is closed. • When locked by key, the automatic release is made inoperative and must be manually unlocked by key. 	<p>Communicating Passage</p> <ul style="list-style-type: none"> • For twin communicating or exit door where one-side operation is required. • Also when space is limited between door and switch panel. • Deadlocking latchbolt. • One knob operation. • Blank rose. • Should be used where rooms have more than one entrance. 	<p>Dummy Trim</p> <ul style="list-style-type: none"> • For non-operational knobs used for decorative trim.
 <p>Outside Inside</p>	 <p>Outside Inside</p>	 <p>Outside Inside</p>

cylinders

cylinder options

The following selection guide indicates the correct cylinder for each locking segment.

Lockset Series: 5300		Types of Cylinder Mechanisms							
		Conventional		Patented Keyway		Security		High Security	
Cylinder Types	Fixed Core	6-pin	7-pin	6-pin	7-pin	6-pin	7-pin	6-pin	7-pin
		Key-In-Knob	1801	N/A	K400	N/A	5801	N/A	N/A

Refer to Yale® KeyMark® and/or Cylinders and Keys Catalog sections for all details and how to order examples.

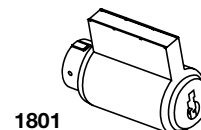

patented keyway cylinders ^{Yale}KeyMark®

For those applications requiring patented key control, Yale® KeyMark® provides the ultimate protection against unauthorized key duplication. *Yale KeyMark* utility-patented Security Leg® keyway features increased resistance against picking and impressioning and can easily retrofit into existing systems. For further details and availability, refer to the separate *Yale KeyMark* catalog.

security cylinders

Security cylinders contain two independent locking mechanisms. The first is a traditional 6-pin tumbler mechanism with spool drivers for greatly increased picking resistance.

The second is an innovative 5-tumbler rotating disc mechanism with sidebar engagement. The rotating discs are spring loaded and block the bottom of the keyway.

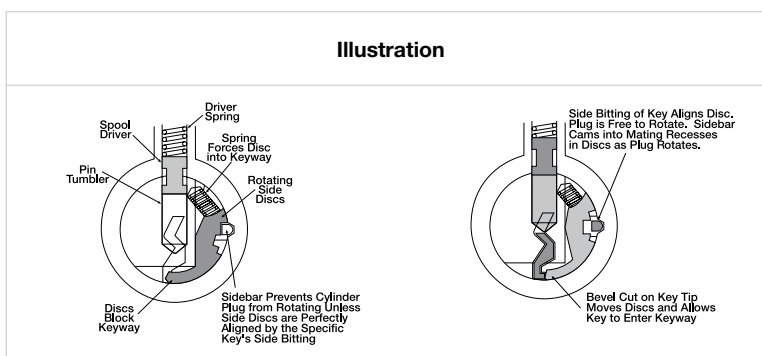

other manufacturer keyway cylinders

	Description	Model Number	Number of Pins
	Schlage® C Keyway. Available 0-bitted or keyed random.	2801	6

latchbolts

plain latchbolts

Model No. 380BN supplied standard with all 5300 series locksets without locking function. Model No. 380BN latchbolt has a 2-1/4" x 1-1/8" front with a 2-3/4" backset and a 1/2" bolt throw. Optional latchbolts with greater backset available to special order.

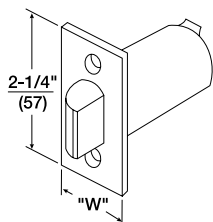

Model No.	Front	Backset	"W" Front Width	Throw	Latch Diameter*
378N	Universal	2-3/8" (60mm)	1" (25mm)	1/2" (13mm)	7/8" (22mm)
380DN	Universal	2-3/4" (70mm)	1" (25mm)	1/2" (13mm)	7/8" (22mm)
3380DN	Universal	3-3/4" (95mm)	1" (25mm)	1/2" (13mm)	7/8" (22mm)
380BN	Universal	2-3/4" (70mm)	1-1/8" (29mm)	1/2" (13mm)	7/8" (22mm)
3380BN	Universal	3-3/4" (95mm)	1-1/8" (29mm)	1/2" (13mm)	7/8" (22mm)

***1/8" sleeve (P/N 14-0378-9001) supplied with all latchbolts to accommodate 1" preps.**

deadlocking latchbolts

Model No. 380AN supplied standard with all 5300 series locksets with locking function. Model No. 380AN latchbolt has a 2-1/4" x 1-1/8" front with a 2-3/4" backset and a 1/2" bolt throw. Optional latchbolts with greater backset available to special order.

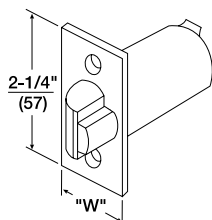

Model No.	Front	Backset	"W" Front Width	Throw	Latch Diameter*
380N	Universal	2-3/8" (60mm)	1" (25mm)	1/2" (13mm)	7/8" (22mm)
380CN	Universal	2-3/4" (70mm)	1" (25mm)	1/2" (13mm)	7/8" (22mm)
3380CN	Universal	3-3/4" (95mm)	1" (25mm)	1/2" (13mm)	7/8" (22mm)
380AN	Universal	2-3/4" (70mm)	1-1/8" (29mm)	1/2" (13mm)	7/8" (22mm)
3380AN	Universal	3-3/4" (95mm)	1-1/8" (29mm)	1/2" (13mm)	7/8" (22mm)

***1/8" sleeve (P/N 14-0378-9001) supplied with all latchbolts to accommodate 1" preps.**

backset extension links

All 5300 Series locksets are regularly supplied with latchbolts with a 2-3/4" backset. Latchbolts with 2-3/8" and 3-3/4" backsets are available to special order. Backset extension links are also available for attachment to latchbolts with 2-3/8" backsets or to latchbolts with 2-3/4" and 3-3/4" backsets to obtain popular backset lengths.

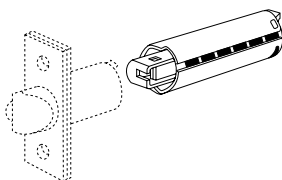

Backset Desired	Latchbolt Backset	Order Extension Model Number
5"	2-3/8"	381N
5"	2-3/4"	381AN
6"	3-3/4"	381AN

attaching screws

(Not regularly supplied when latchbolt ordered separately).

For All Latchbolts

#8-8-32 x 3/4" Phillips flat head combination wood and machine screws. P/N 81-2012-0416

All latches have universal fronts, so they fit flat and beveled door fronts. When ordering latchbolts, specify Model No. x Finish (e.g., 380N x 626). Available in 606, 612, 613, 626 and 722.

strikes

Yale® 5300 locks are available with a variety of strike options. All strikes are located on the same vertical and horizontal center lines as the latchbolt. Some strikes are available in a variety of lip lengths to accommodate varying thickness of doors and frames. To determine the proper length of the lip, measure from the center line of the strike to the edge of the jamb, accounting for any interfering trim (i.e. wood molding) and then add 1/4" (6mm) for curved lip. All strikes are reversible. Strikes are fabricated of either brass, bronze or stainless steel, depending on the lockset trim finish. When ordering strikes separately, specify the finish required.

<p>Model No. 497 ANSI Strike (Standard) For door and frames with ANSI/BHMA A156.115 preparations. 1-1/4" supplied standard. 1-1/8", 1-1/2", and 1-3/4" lip lengths available by special order.</p>	<p>Model No. 371 T-Strike (Optional) 1-1/4" curved lip supplied standard. 1", 1-1/2", 1-3/4", and 2" curved lip lengths available by special order. Wrought strike box supplied.</p>	<p>Model No. 497B Blank ANSI Strike (Optional) Available to special order. Installed in frame with standard ANSI/BHMA A156.115 preparation to replace the strike when the lockset has been removed from the door.</p>
<p>Model No. 70S Full Lip Strike (Optional) With full lip anti-rattle tab. Wrought strike box supplied.</p>	<p>Model No. 71S Full Lip Strike (Optional) 1/4" radius. Similar in dimensions and function to the 70S Strike but with radius corners for easy mortising by power tools. Anti-rattle tab. Wrought strike box supplied.</p>	<p>Model No. 202 Strike Box for ANSI Strike (Optional) Specify 497 x 202</p>

attaching screws

(Not regularly supplied when strikes ordered separately).

For Model Nos. 371, 70S, and 71S

#8-8-32 x 3/4" (19mm) Phillips flat head combination wood and machine screws.

P/N 81-2012-0416

For Model Nos. 497 and 497B

#12-12-24 x 1" Phillips flat head combination wood and machine screws.

P/N 81-2012-0620

NOTE: When ordering strike or attaching screws individually, specify the finish required; i.e. 497 x 202 x 606; 81-2012-0620 x 606.

ordering information

From this outline select the Model Number for the Yale® 5300 Series Cylindrical Lockset you require.

Design	Function	Hand	*Latch	*Strike	*Cylinder	Door Thickness	Supplementary Specifications	Keying Level	Finish
See page 3	See pages 4-5	Specify	See page 7	See page 8	See page 6	See page 2	Beveled front, specific keying, extension links, strike lip length, etc. (Specify by Model Number where available.)	Highest Keying Level: i.e. MK, GMK, GG MK	See page 2

*If other than standard is required, specify by catalog model number.

ordering example

Quantity	Design	Function	Hand	Latch	Strike	Cylinder	Door Thickness	Finish
100	CA	5307	RH	380N	497	1801	1-3/4"	626

packing

Each box has a strike, paper template, combination wood and machine screws and easy-to-follow instructions. Cylinder functions are supplied with two keys and furnished right hand unless otherwise specified. Ten shelf boxes to a case.

sample specification

All locksets shall be 5300 Series Grade 2 cylindrical knob locksets as assembled by Yale Locks and Hardware.

Lockset mechanisms are to be constructed of heavy-gauge cold-rolled steel, zinc plated chromate to protect against rust and corrosion. Locksets shall be adjustable to fit doors between 1-3/8" (35mm) to 1-3/4" (44mm) thick.

Locksets shall be reversible for either right hand or left hand doors and be easily installed with out the use of any special tools. They shall be installed in a 2-1/8" face bore and a 1" hole in the edge of the door.

Knobs and roses shall be heavy cold forged reinforced. Outside knob on keyed locksets shall be removable only when the designated key is in the cylinder.

Locksets shall have the capability of accepting 6 pin standard component cylinder and security cylinders to provide expansion capacity for masterkey systems.

Latchbolts shall be stainless steel and have a standard 1/2" throw.

Locksets shall carry a 2-year mechanical warranty.

Locksets shall comply with the following certification:

- UL/cUL up to and including 3 hours fire rating
- ANSI/BHMA A156.2 series 4000 Grade 2
- ANSI/BHMA A156.115 or A156.115-W preparation



5300 series | cylindrical knob locks

notes

online literature and templates

For the latest information on Yale Locks & Hardware products, visit our website at: www.yalelocks.com

Click on the "Product Information" button to find:

- Catalogs
- Parts manuals
- Templates
- Specifications
- Installation instructions

Yale® customers can click on the ebusiness symbol on the website to register for an ebusiness account to:

- Check the status of orders
- Check availability of Quick-Ship items
- Track your order and confirm delivery
- Receive email notification of template changes
- And More...

Or contact us at:

U.S.A.

Yale Locks & Hardware

Address: 100 Yale Avenue, Lenoir City, TN 37771-3226

Tel: 1-800-438-1951 • Fax: 1-800-338-0965 • www.yalelocks.com

Canada:

ASSA ABLOY Door Security Solutions Canada

Address: 160 Four Valley Drive, Vaughan, Ontario L4K 4T9

Tel: 1-800-461-3007 • Fax: 1-800-461-8989 • www.assaabloy.ca

International:

ASSA ABLOY Americas International

Tel: 1-905-821-7775 • Fax: 1-905-821-1429 • www.assaabloyai.com

Yale Locks & Hardware is a division of Yale Security Inc., an ASSA ABLOY Group company.

Yale® is a registered trademark of Yale Security Inc., an ASSA ABLOY Group company. KeyMark® and Security Leg® are registered trademarks of Medeco Security Locks, Inc., an ASSA ABLOY Group company. Other products' brand names may be trademarks or registered trademarks of their respective owners and are mentioned for reference purposes only. These materials are protected under U.S. copyright laws. All contents current at time of publication. Yale Security Inc. reserves the right to change availability of any item in this catalog, its design, construction, and/or its materials. Copyright © 2001, 2010, Yale Security Inc., an ASSA ABLOY Group company. All rights reserved. Reproduction in whole or in part without the express written permission of Yale Security Inc., an ASSA ABLOY Group company is prohibited.

YALE, with its unique global reach and range of products, is the world's favorite lock.

ASSA ABLOY is the global leader in door opening solutions, dedicated to satisfying end-user needs for security, safety and convenience.

42120-7/10RE